

# ADEL 48"

**Category:** Bathroom Vanity

**Material:** Wood

**Dimensions:**

47.1"(L) x 19.8"(W) x 14.5"(H)

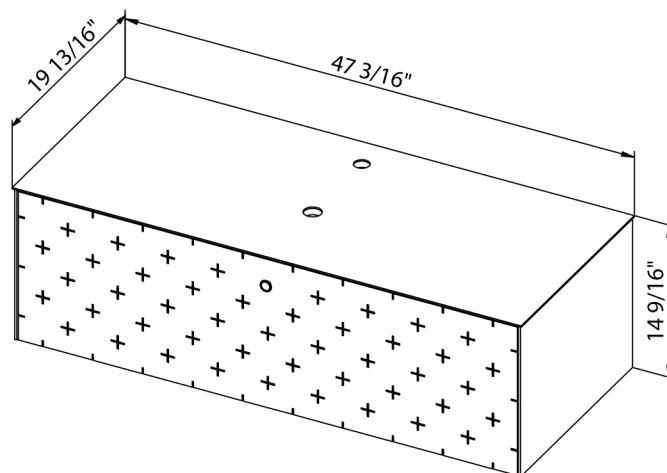

## Technical Data

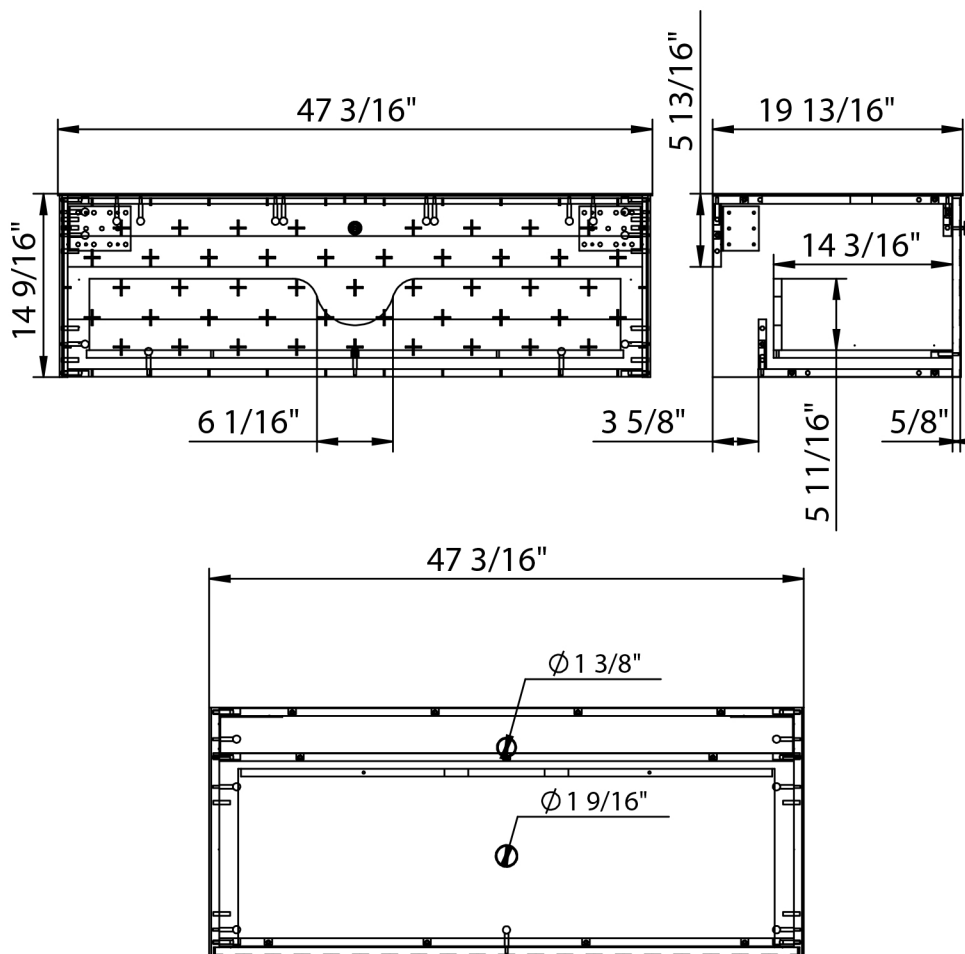

\*Numbers are in inches

### TOOLS REQUIRED FOR ASSEMBLY

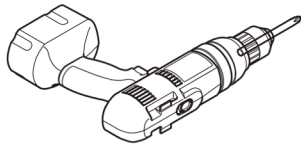

Electrical Drill

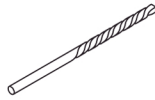

Drill Bit

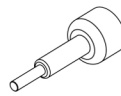

Bolt Bit

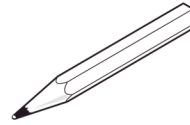

Pencil

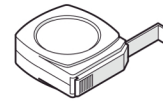

Tape Measure



Phillips  
Screwdriver

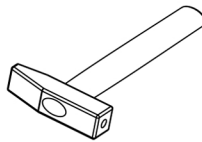

Hammer

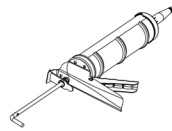

Silicone

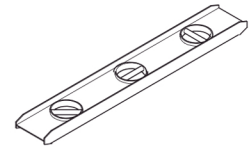

Level

### FURNITURE

**A**

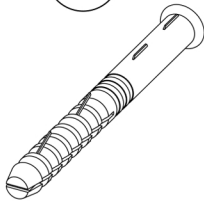

4 PCS

**B**

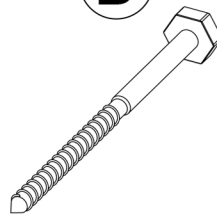

4 PCS

**C**



4 PCS

**D**



2 PCS

### Wall Preparation

The recommended height for a console cabinet with sink is 33-1/2". This requires installing a 14" wide wood panel to a height of 34-1/4". If an alternate height desired, adjust the rough-in and backing material heights using the dimensions provided.

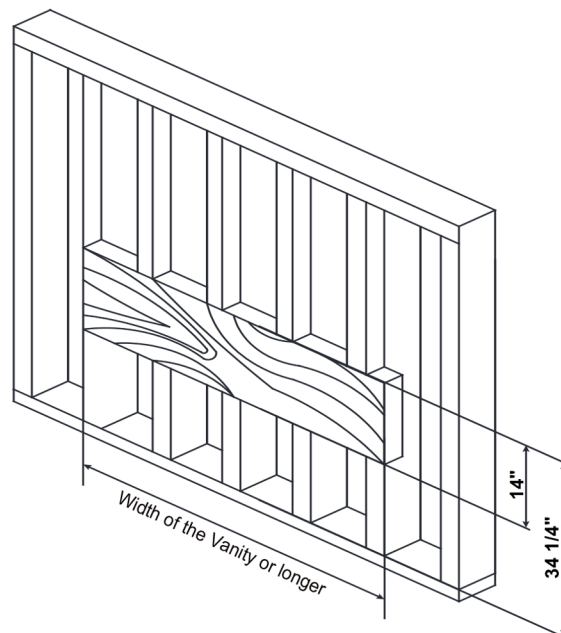

**STEP 1.**

Marking for the cabinet  
Having decided on the location of the cabinet, we mark and drill holes in the wall measuring the distance A, B, C

**WARNING:**  
Before installing the cabinet must be removed drawers.

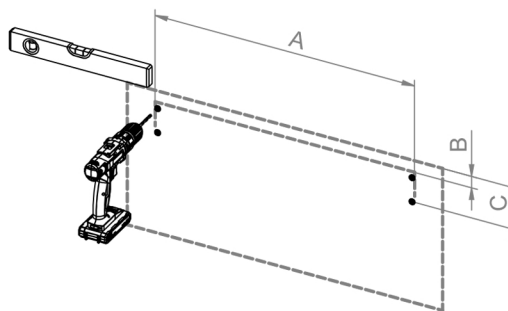

**STEP 2.**

Install the cabinet on the drilled holes

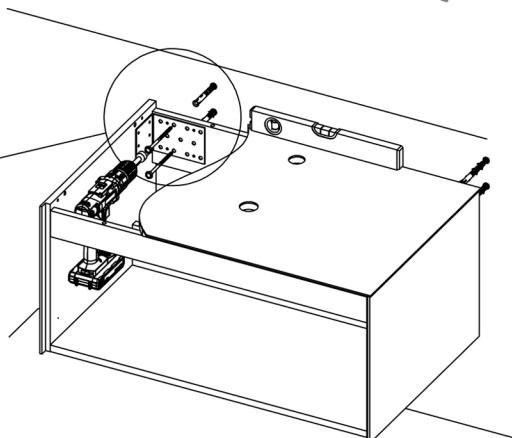
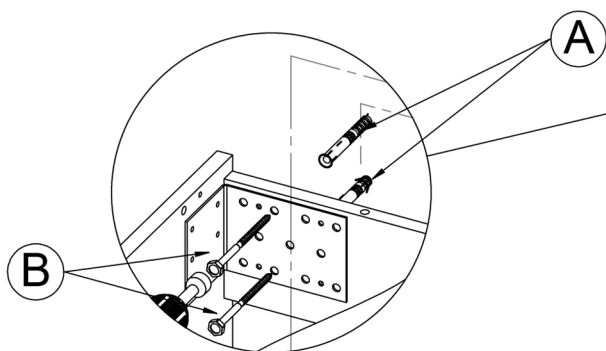

**STEP 3.**

Install sink top with Silicone

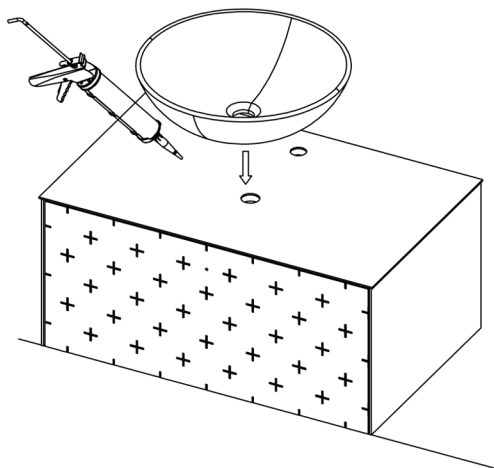

**STEP 4.**

Fill the side against the wall with Silicone and finish

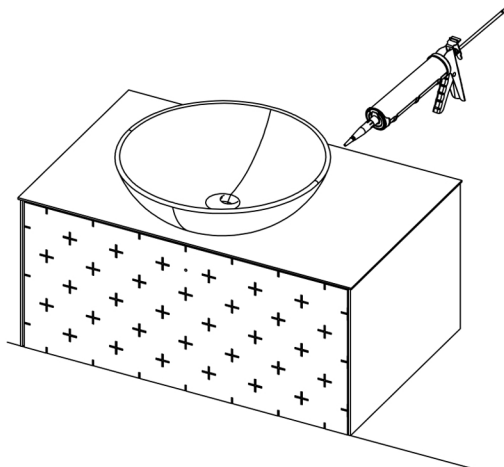

**STEP 5.**

Attach the handles to the cabinet

